

# HEDEFSAN

Proje:	HD DRIVER-DİŐLİLİ
Tarih:	13/06/2018
Versiyon:	2.0
Çizim:	Tayyip BARAN
Kontrol:	Ferdi TAŐKAYA

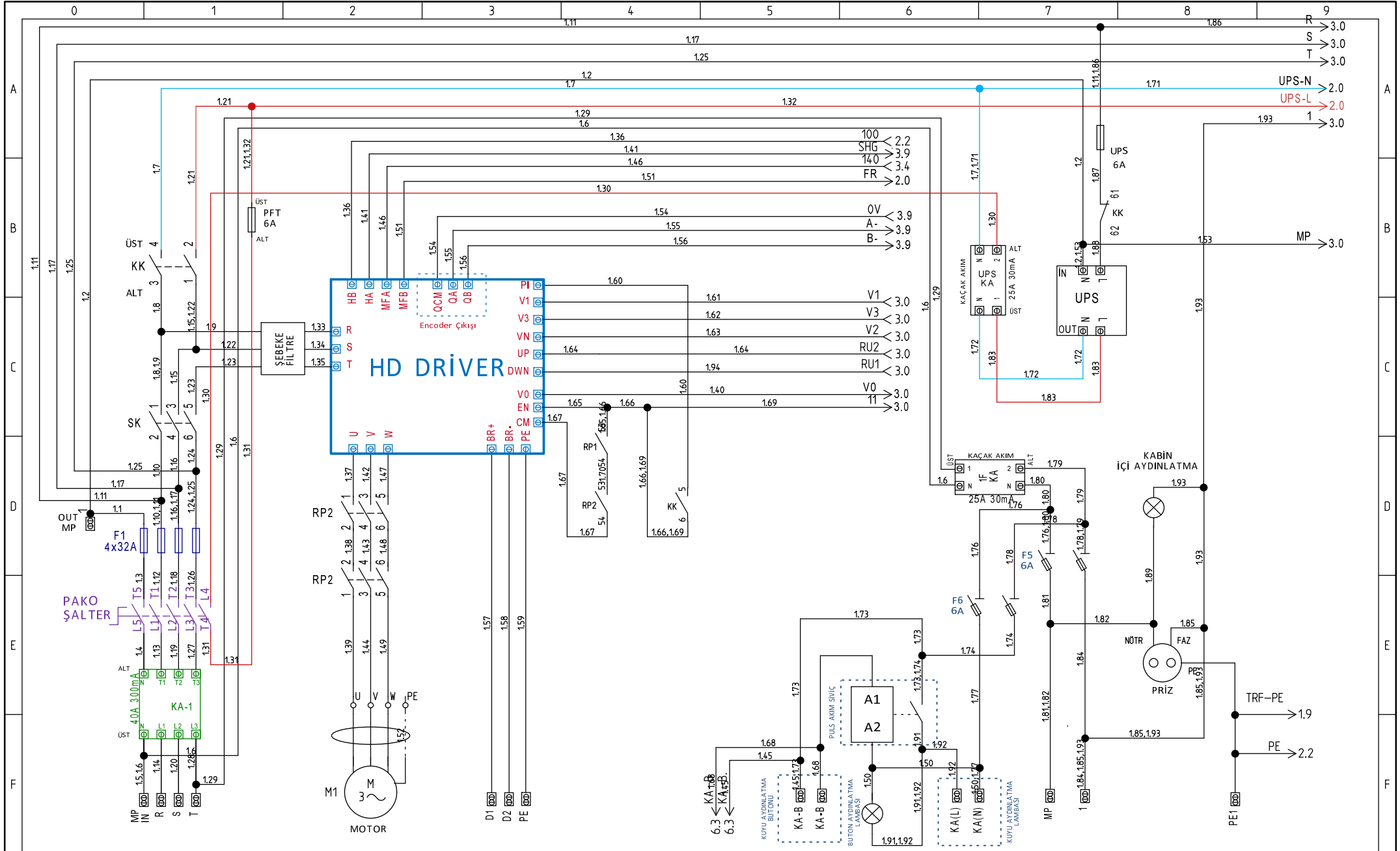

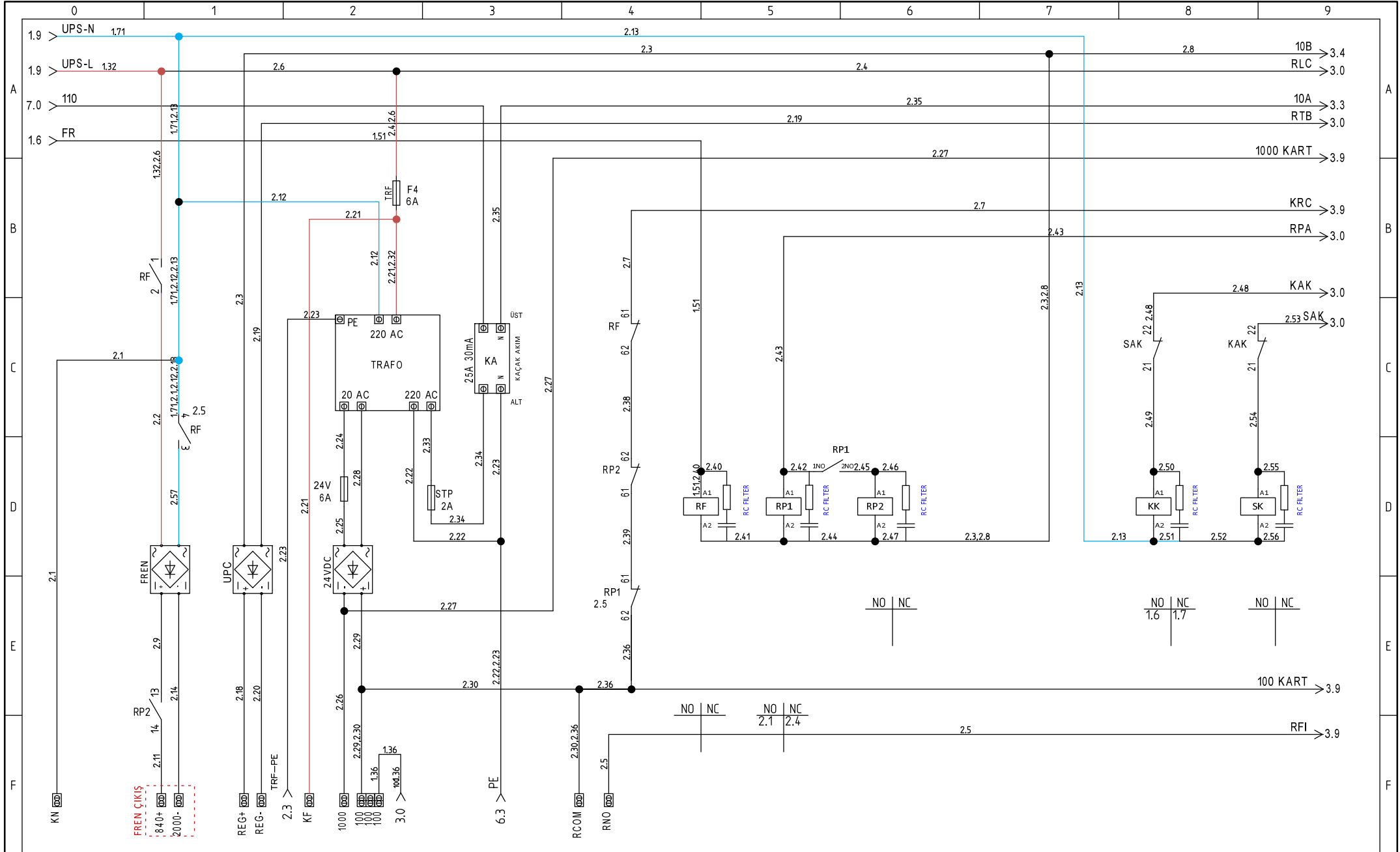

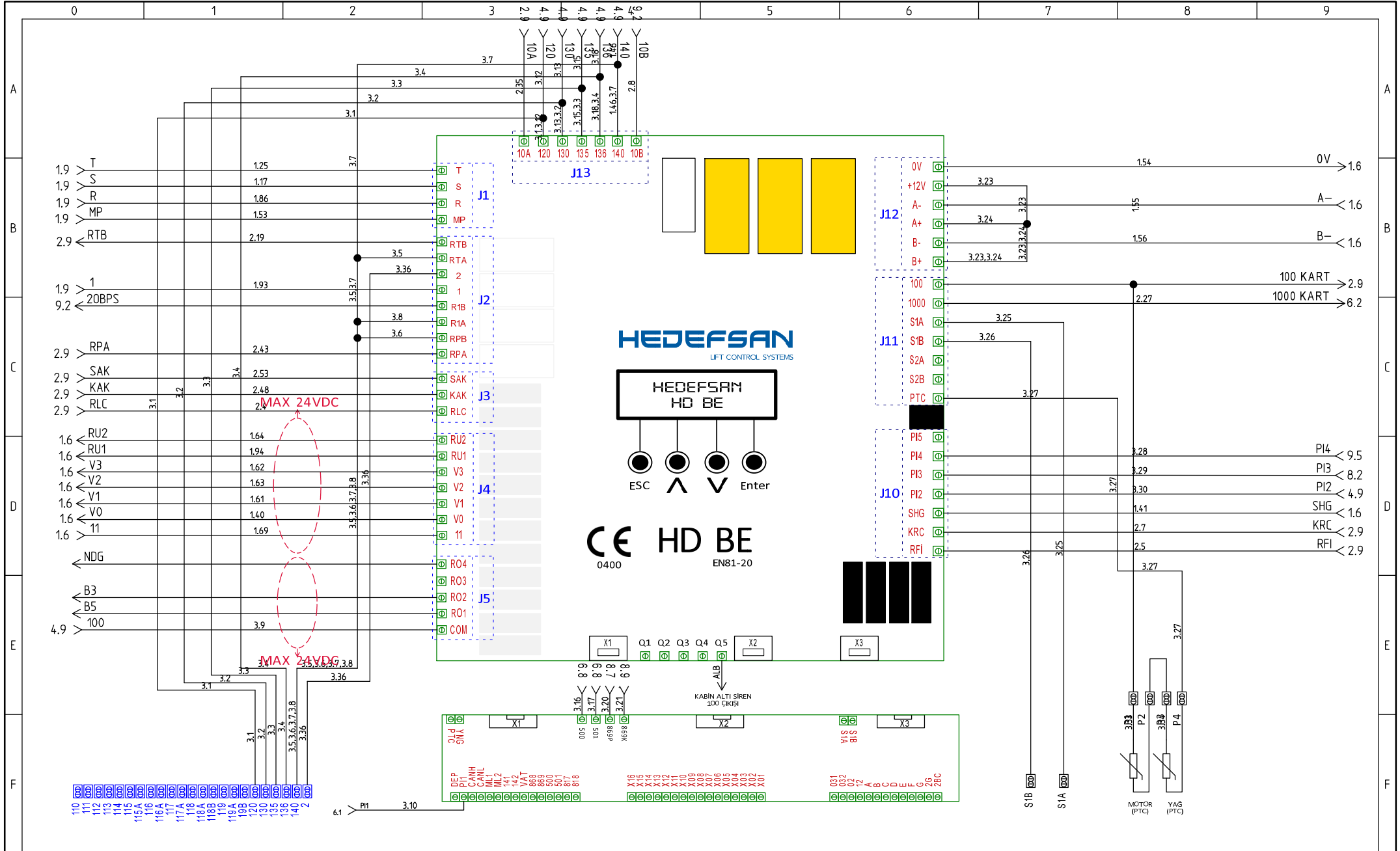

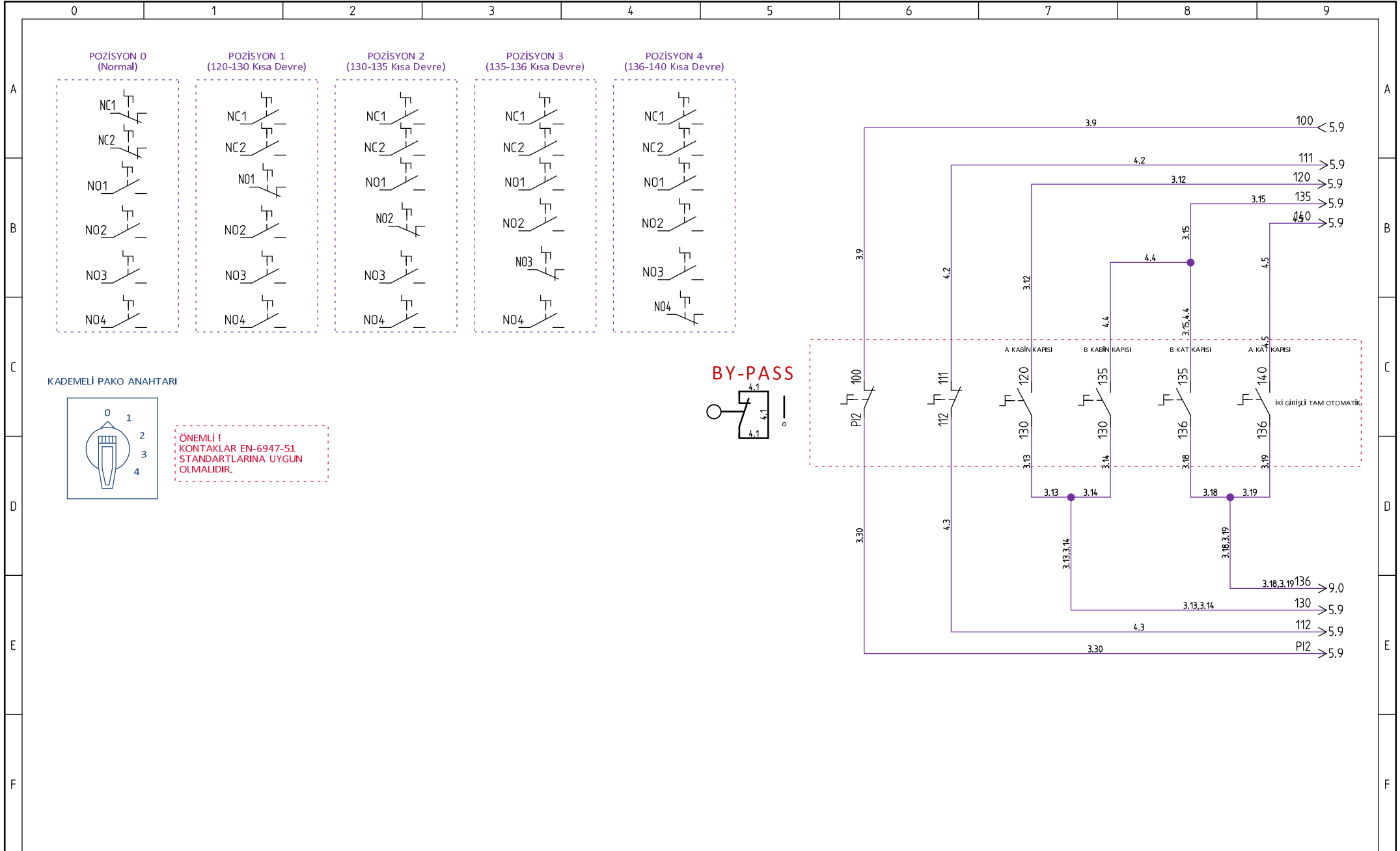

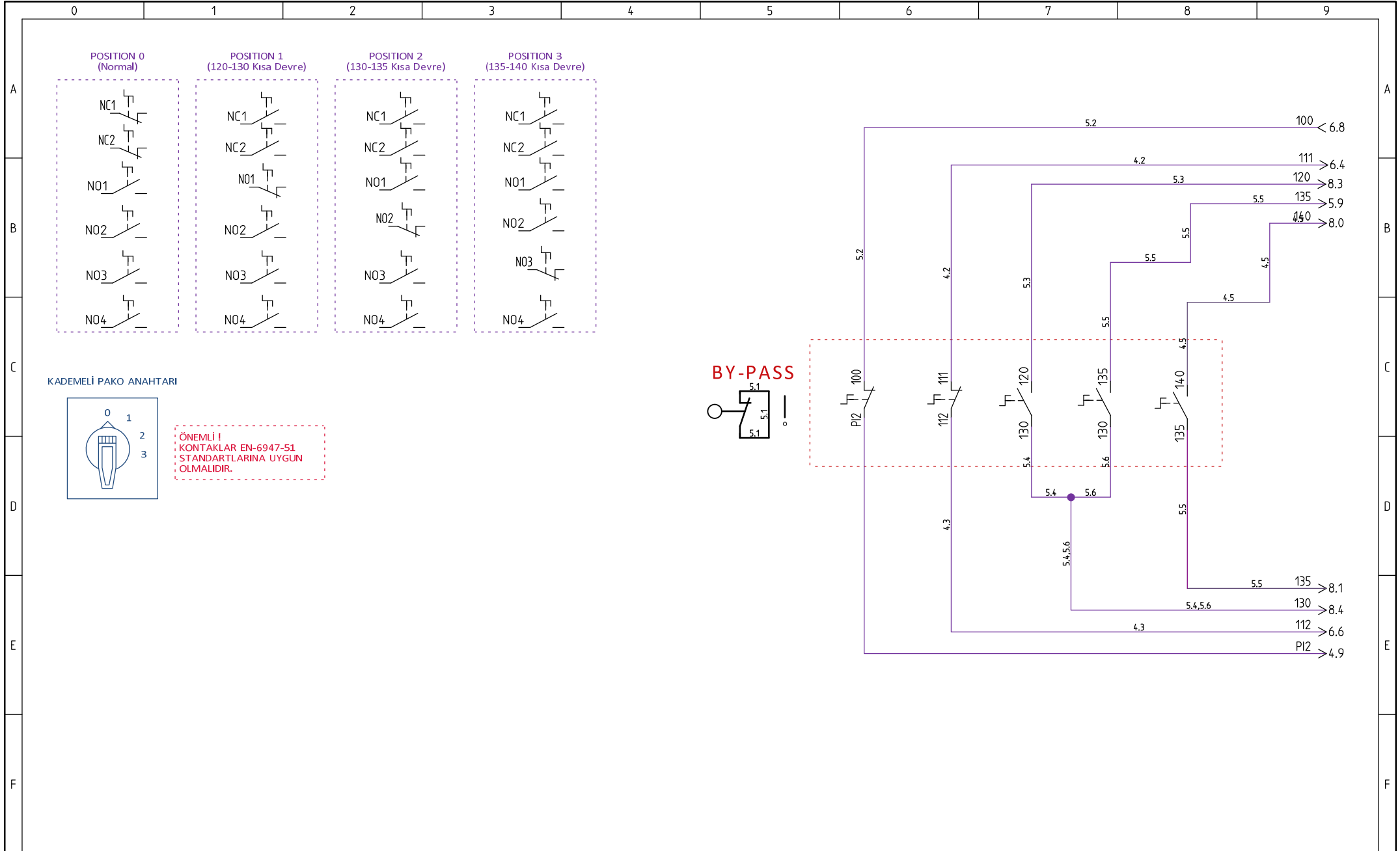

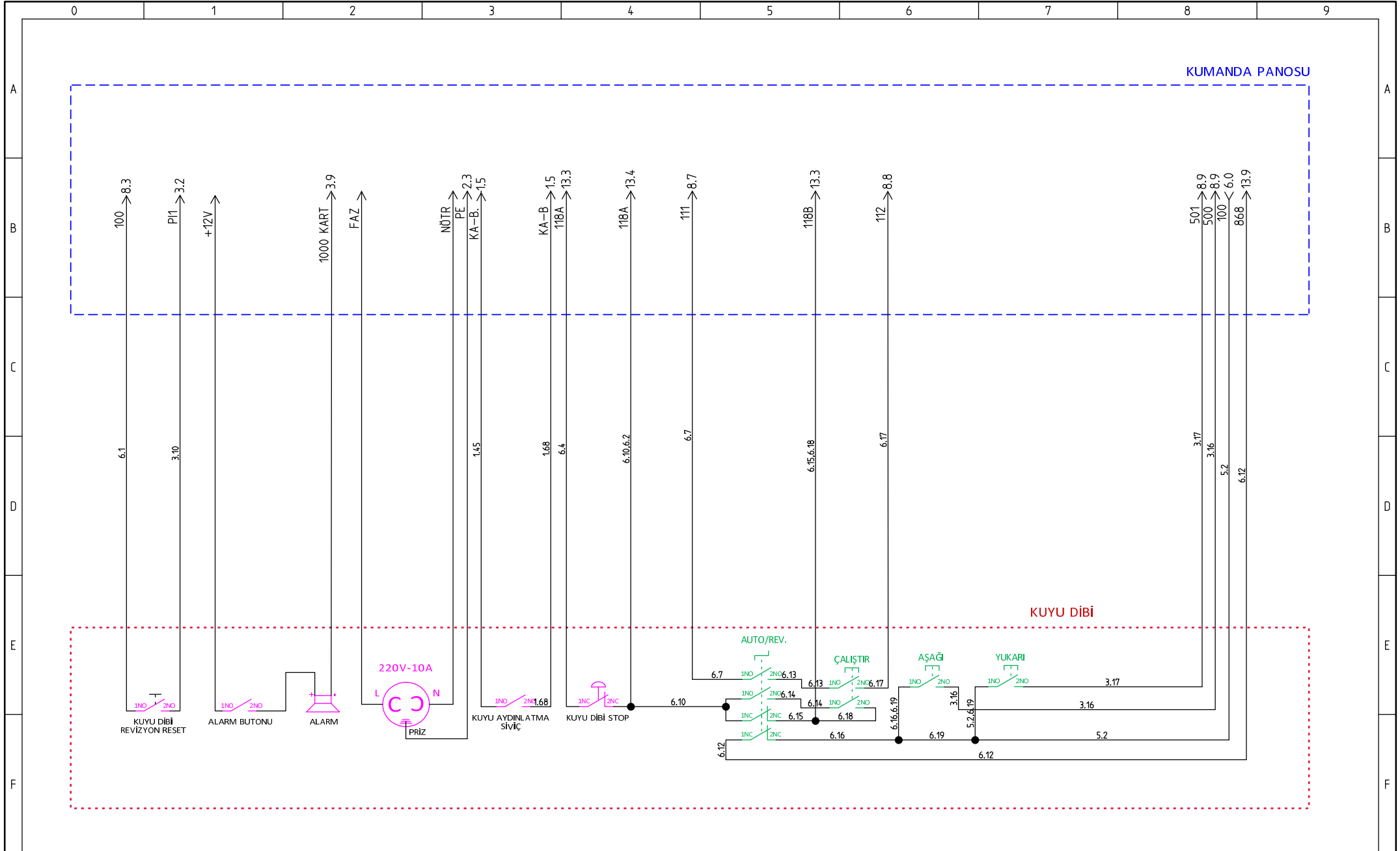

# EMNİYET DEVRESİ

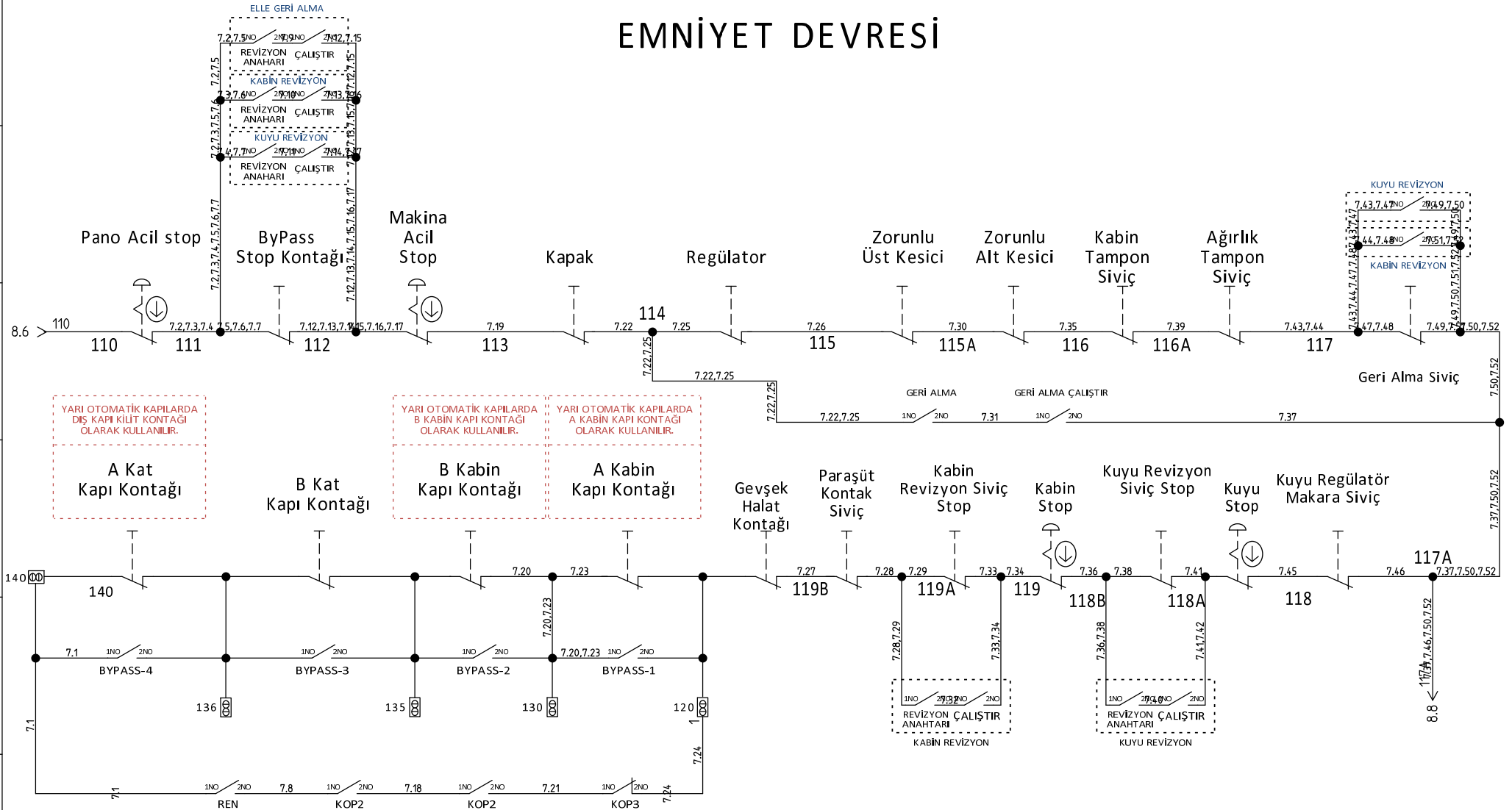



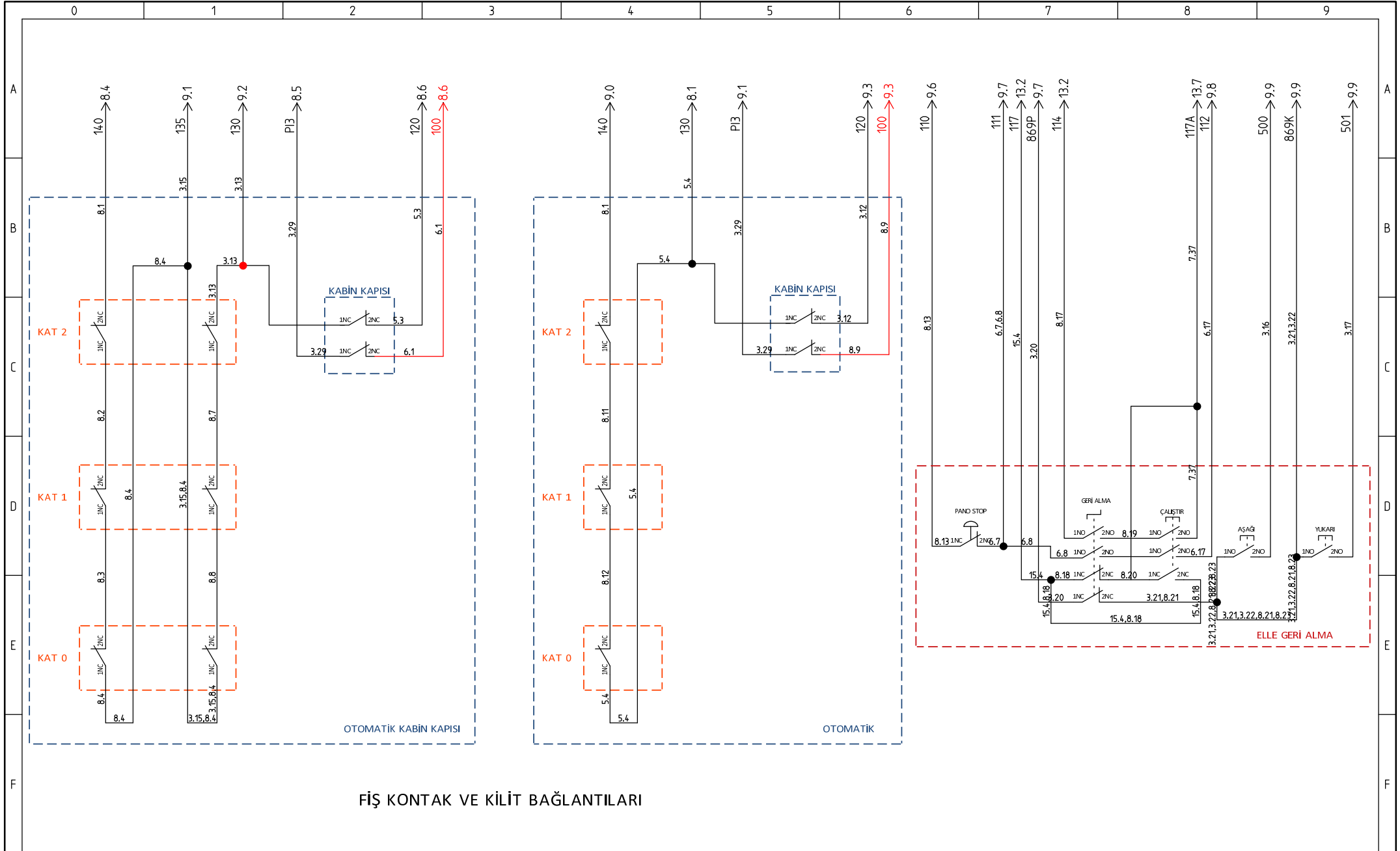

### FİŞ KONTAK VE KİLİT BAĞLANTILARI

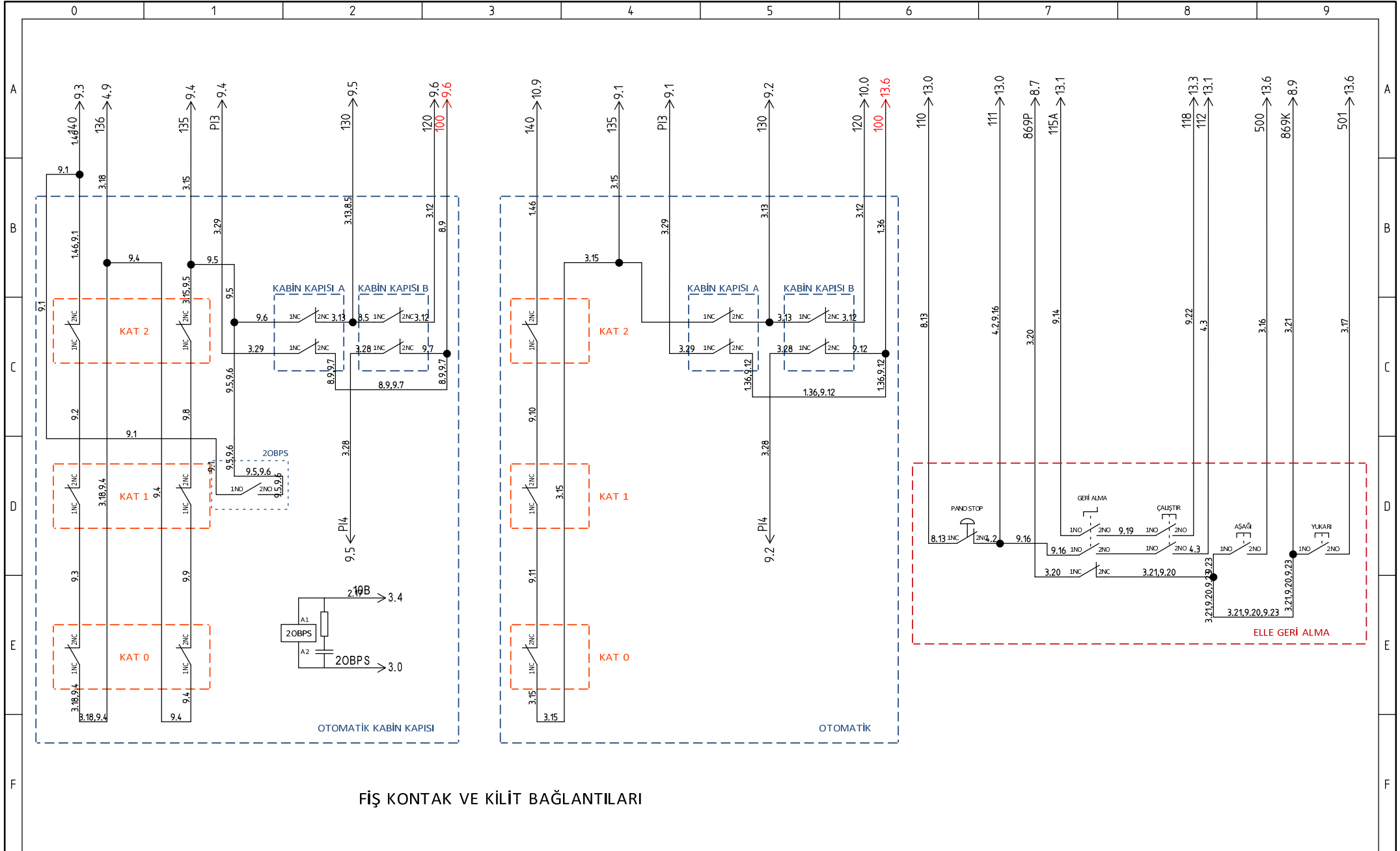

FİŞ KONTAK VE KİLİT BAĞLANTILARI

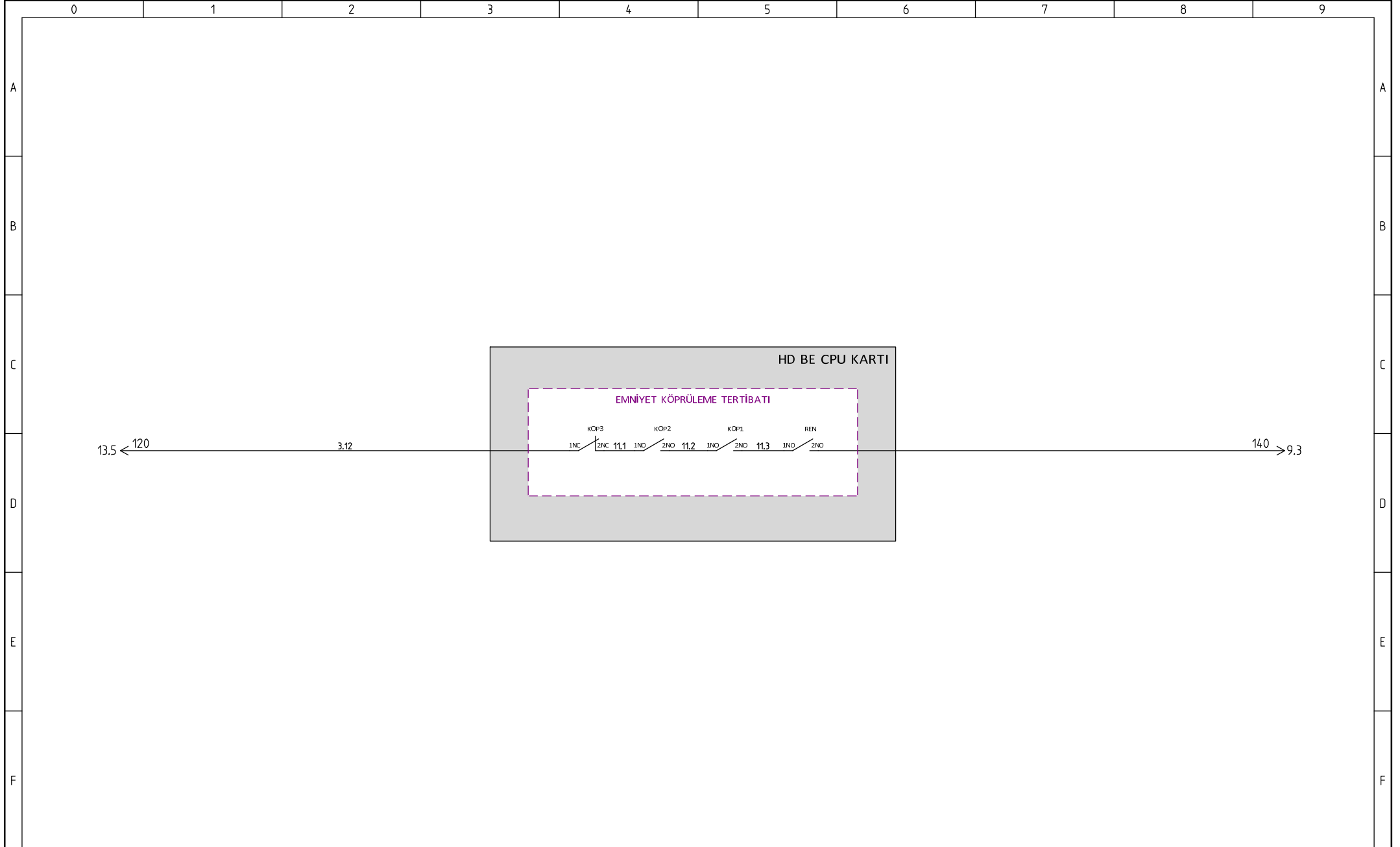

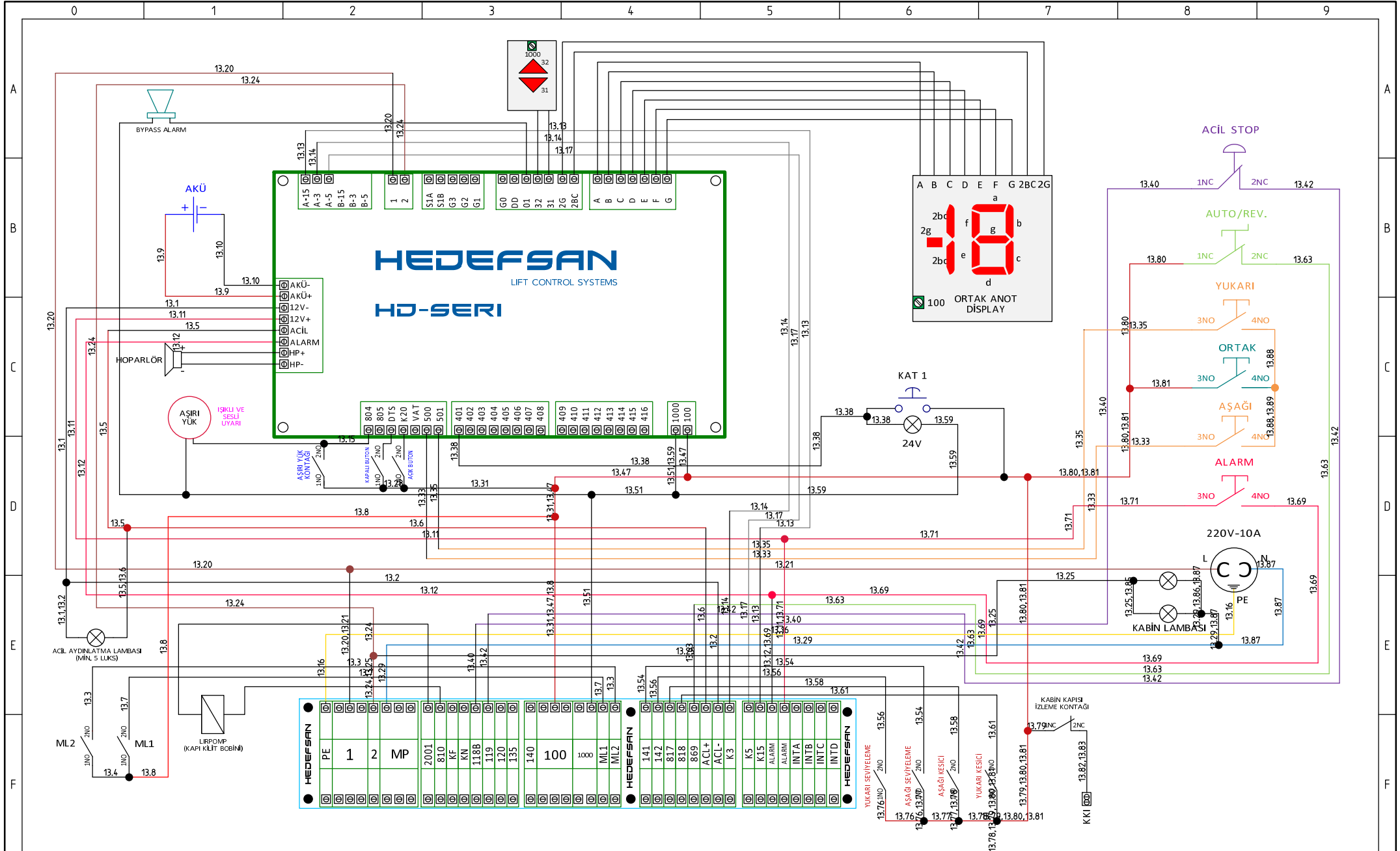

0 1 2 3 4 5 6 7 8 9

A

B

C

D

E

F

A

B

C

D

E

F

FREN TEST A

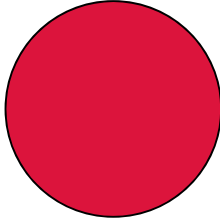

FREN TEST B

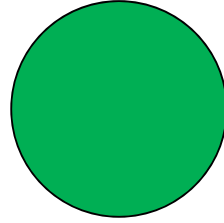

REGÜLATOR  
KİLİT

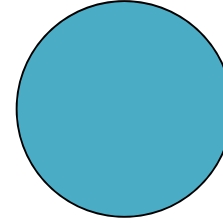

REGÜLATOR  
BIRAK

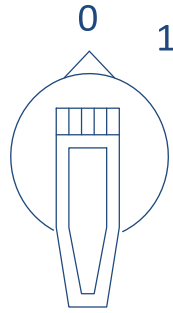
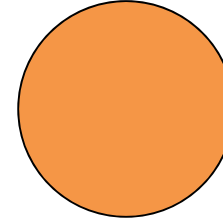

FREN TEST

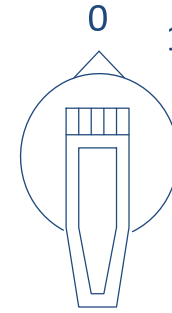

REGÜLATOR TEST

Not: Fren test kutusunu örnekteki gibi etiketleyiniz.

