

HEDEFSAN

Proje:	HD DRIVER-DİŐLİLİ
Tarih:	06/03/2018
Versiyon:	2.0
Çizim:	Tayyip BARAN
Ürün:	HD BE

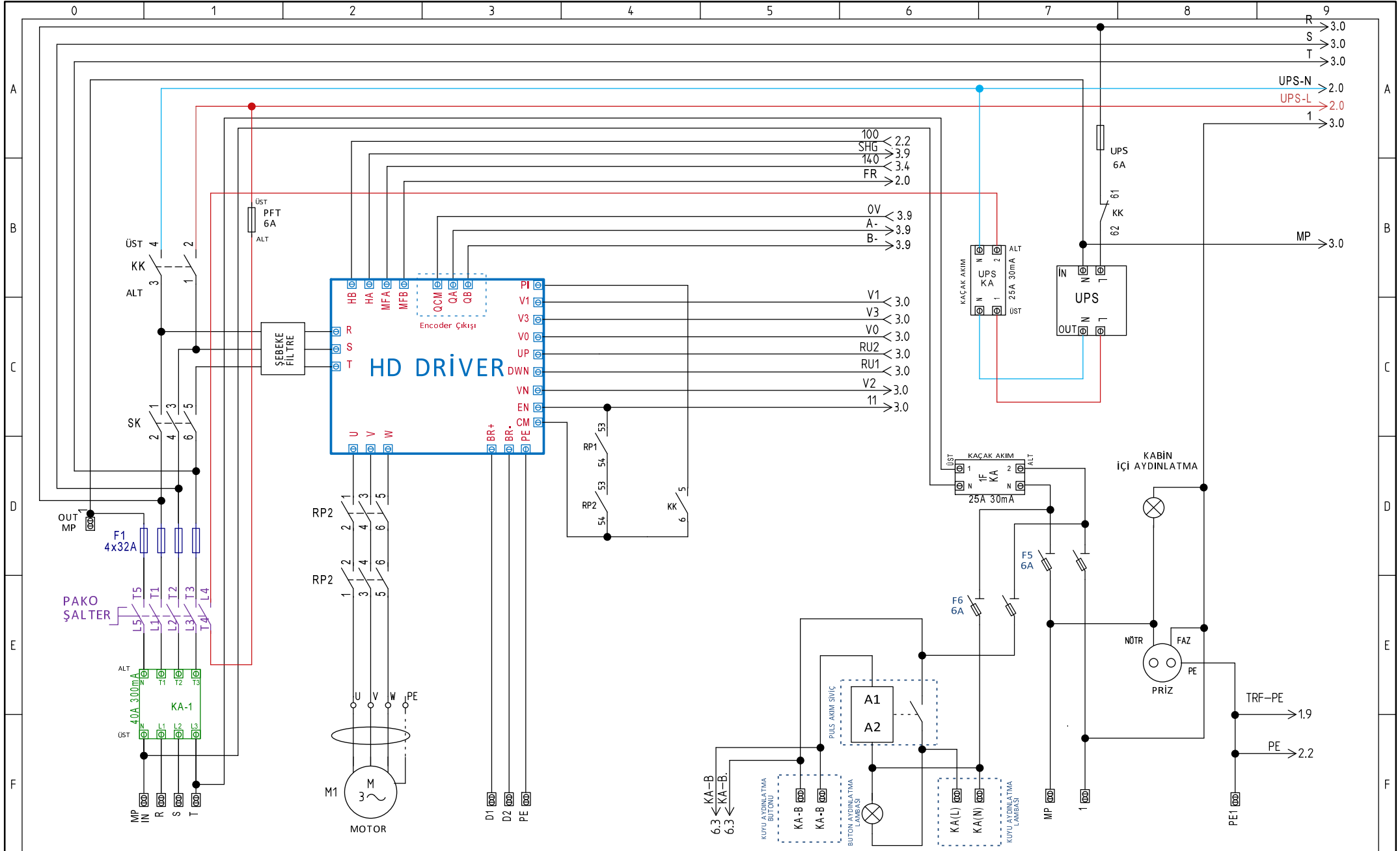

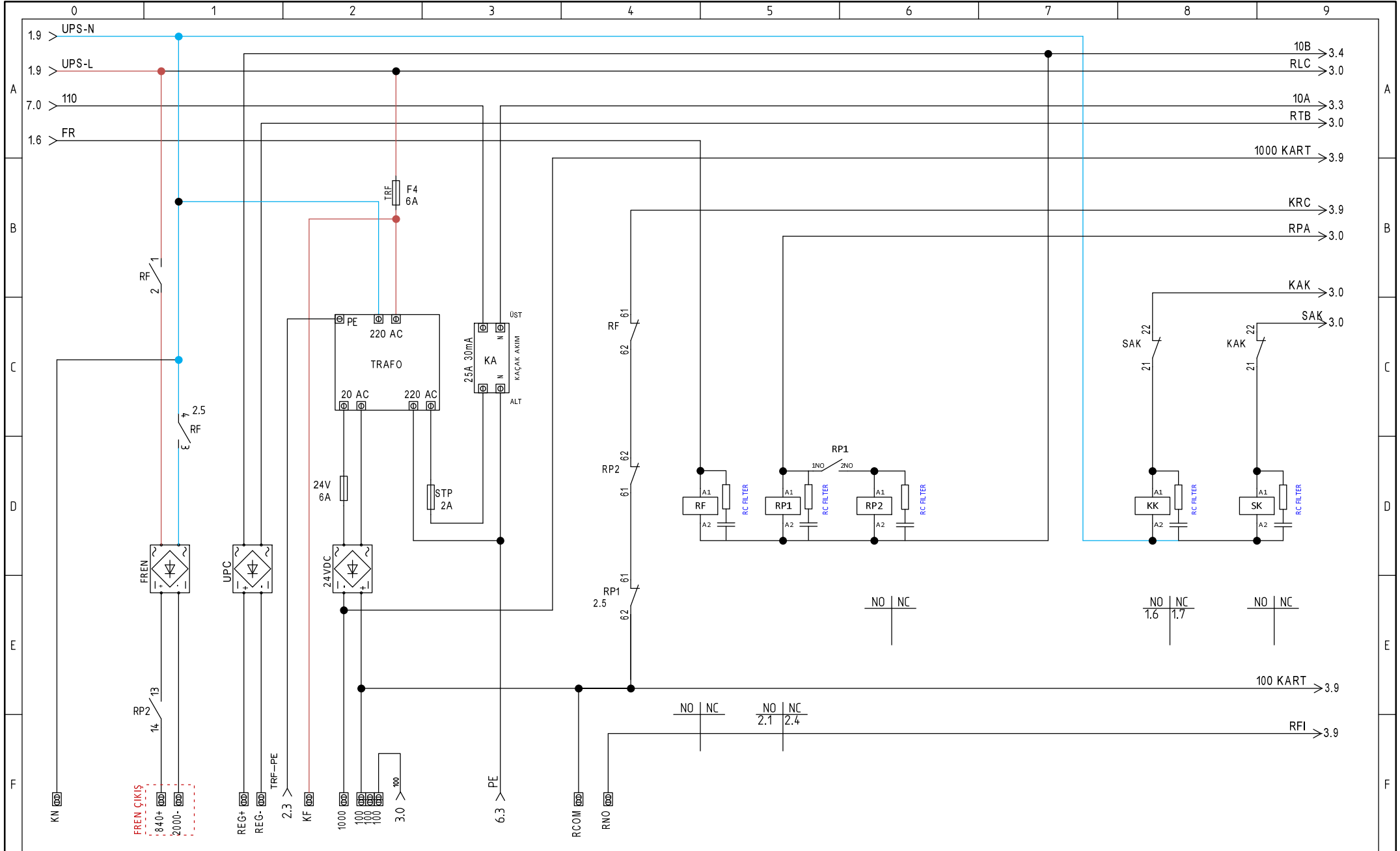

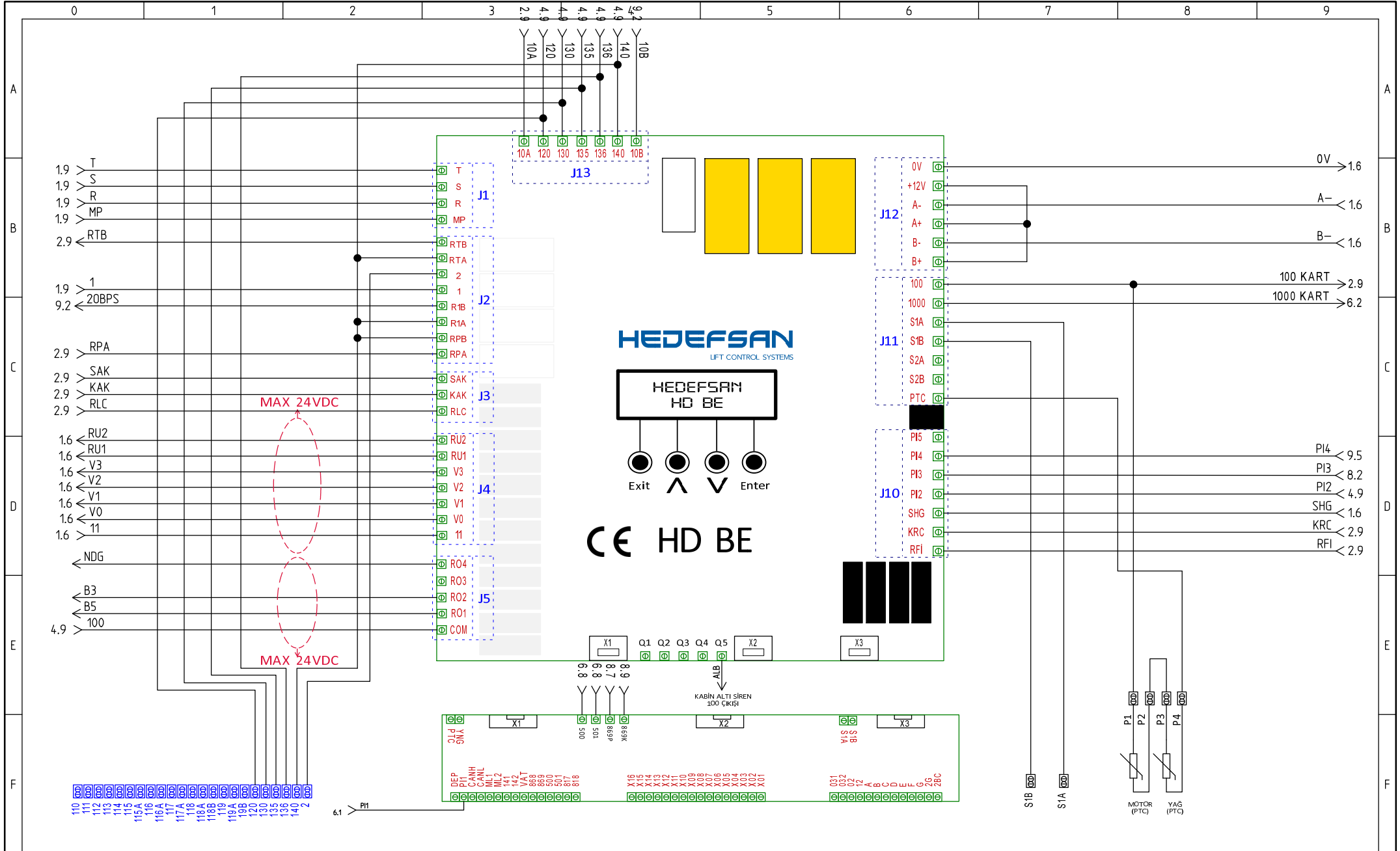

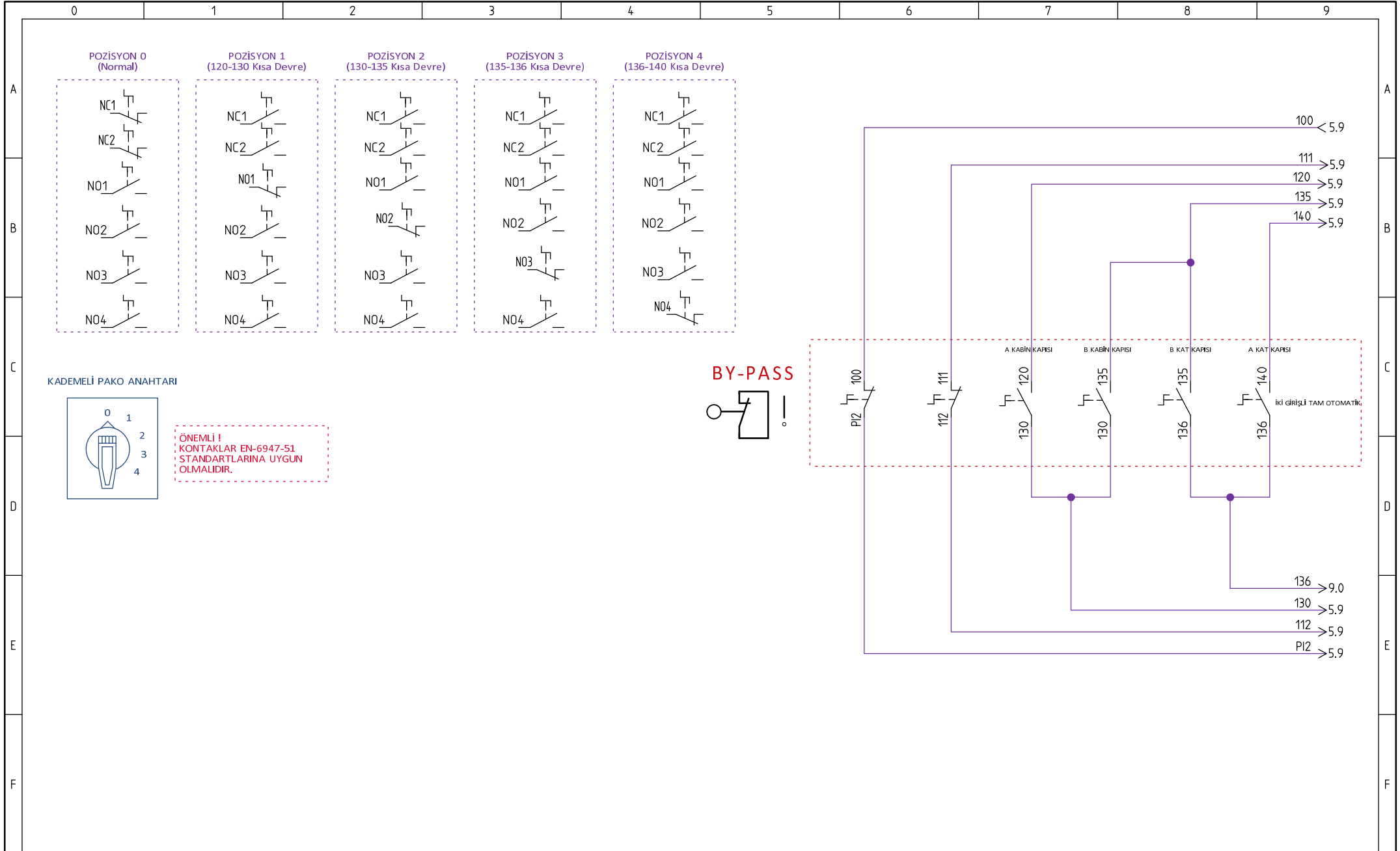

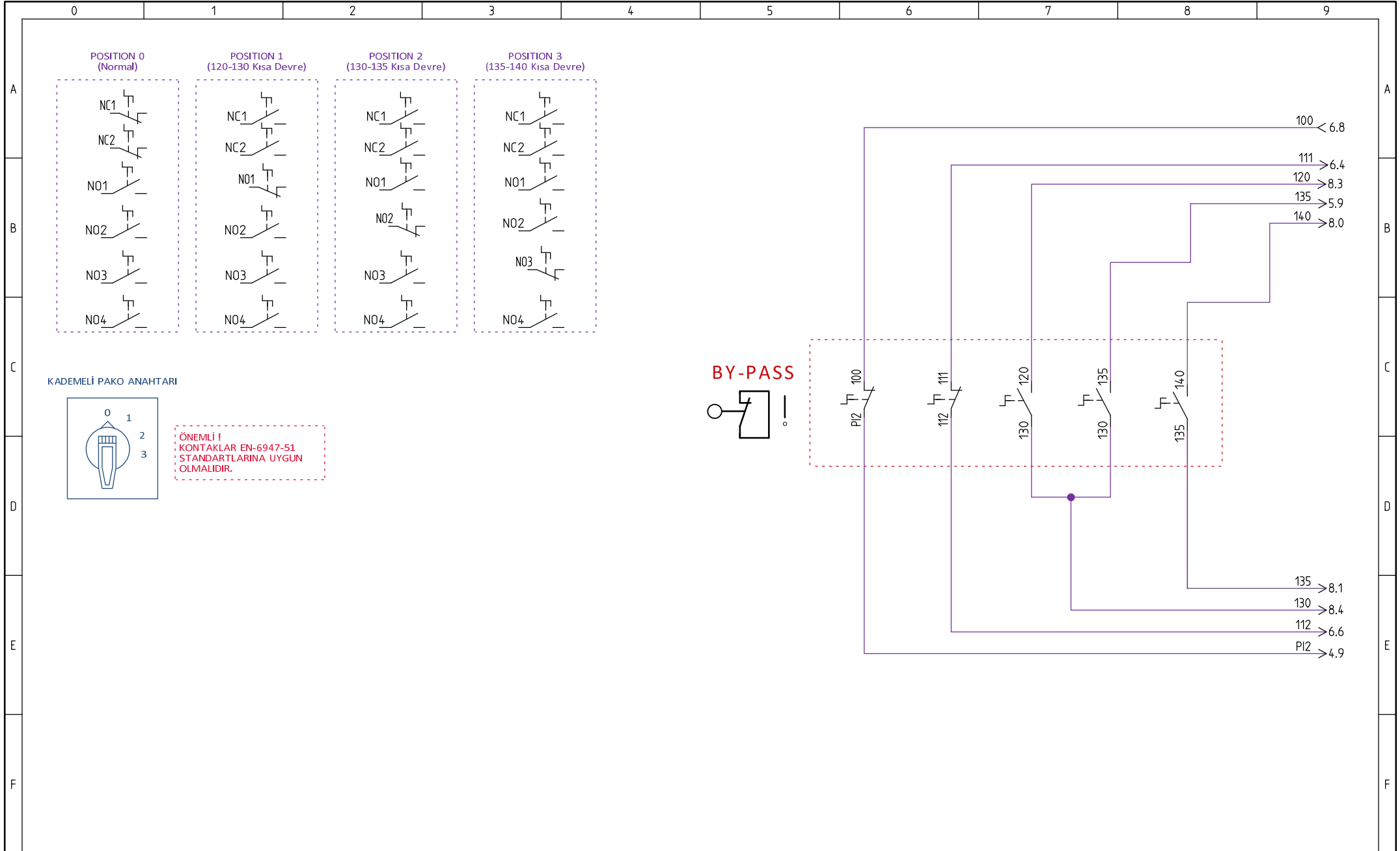

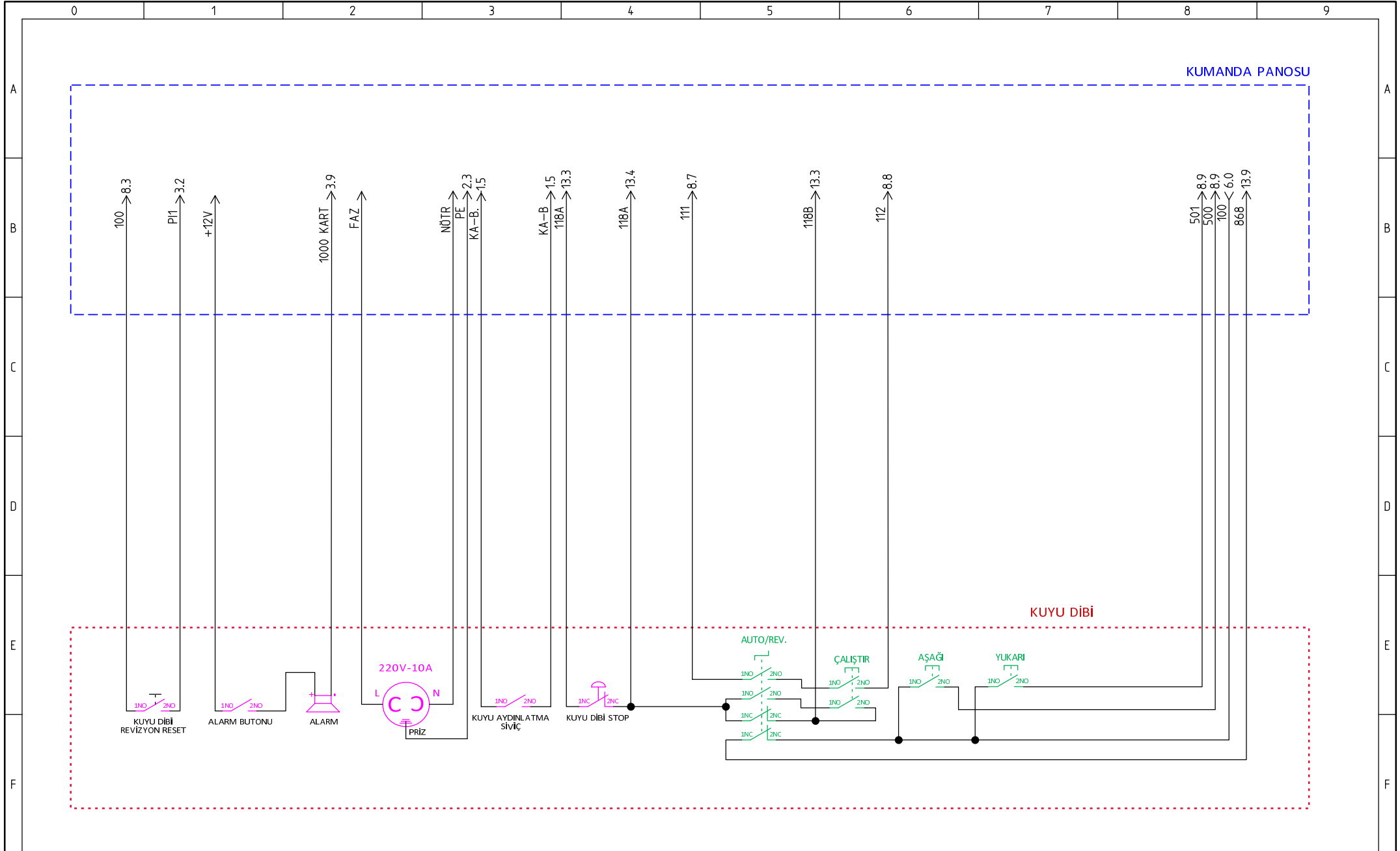

EMNİYET DEVRESİ

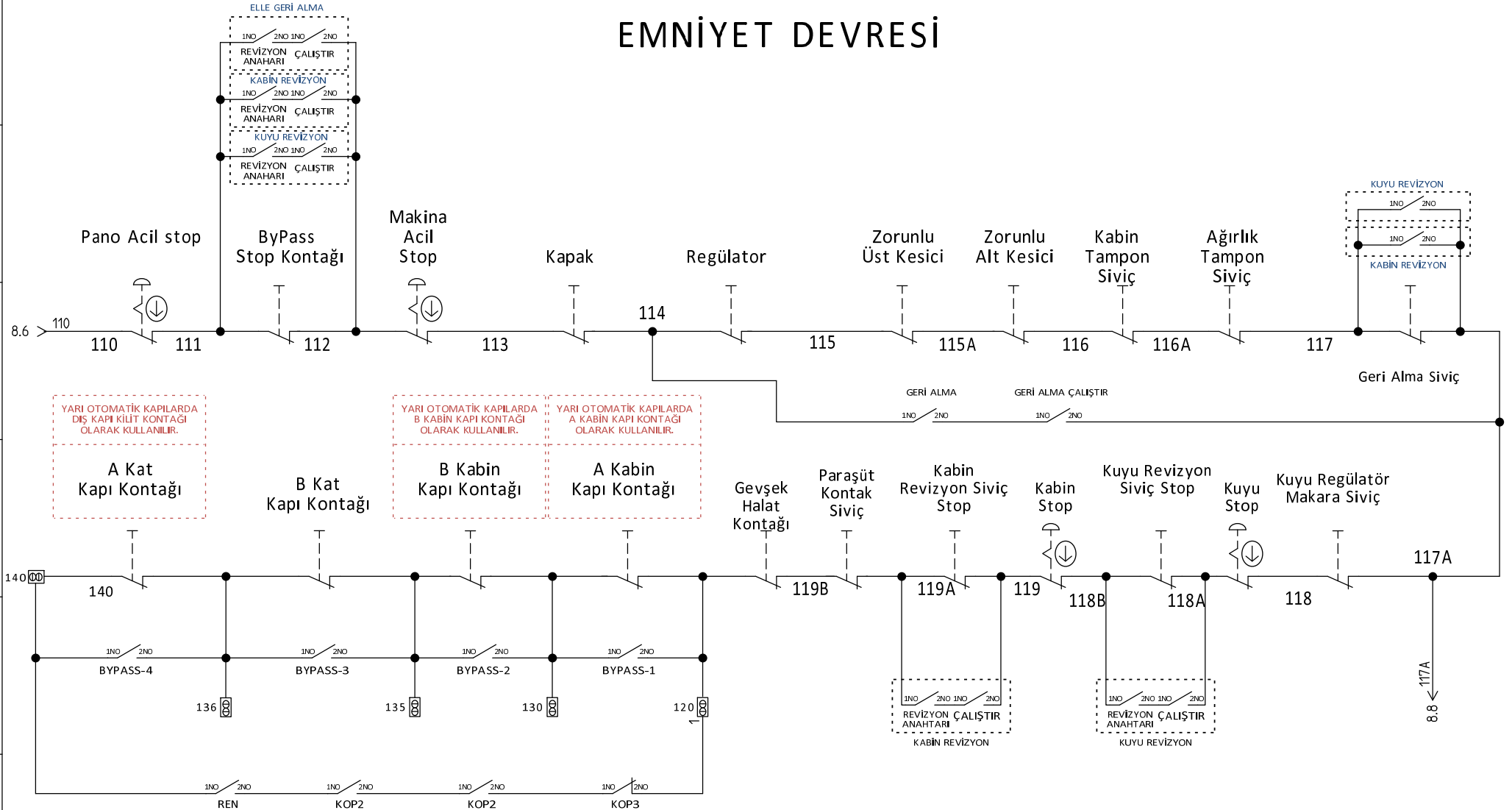

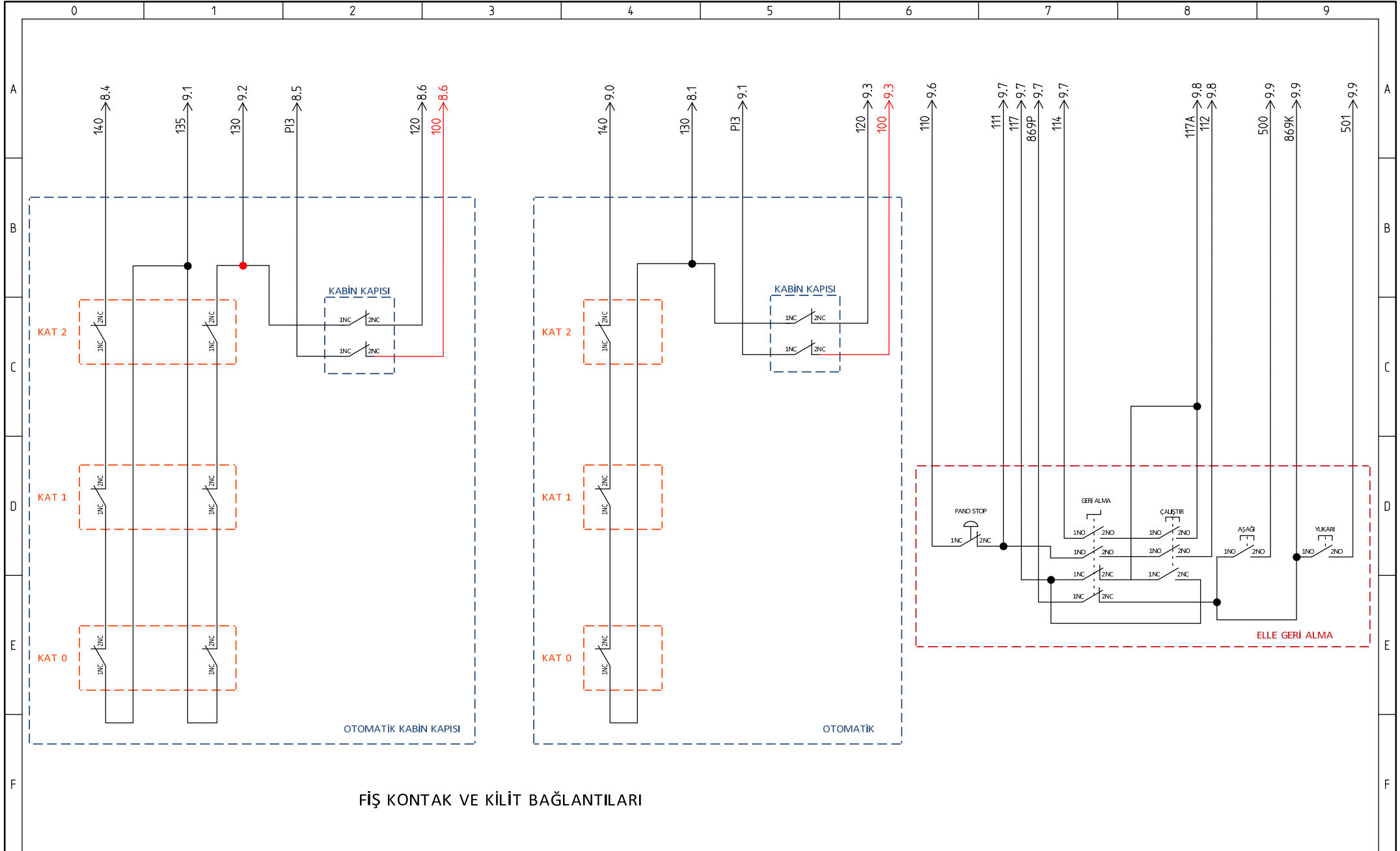

FİŞ KONTAK VE KİLİT BAĞLANTILARI

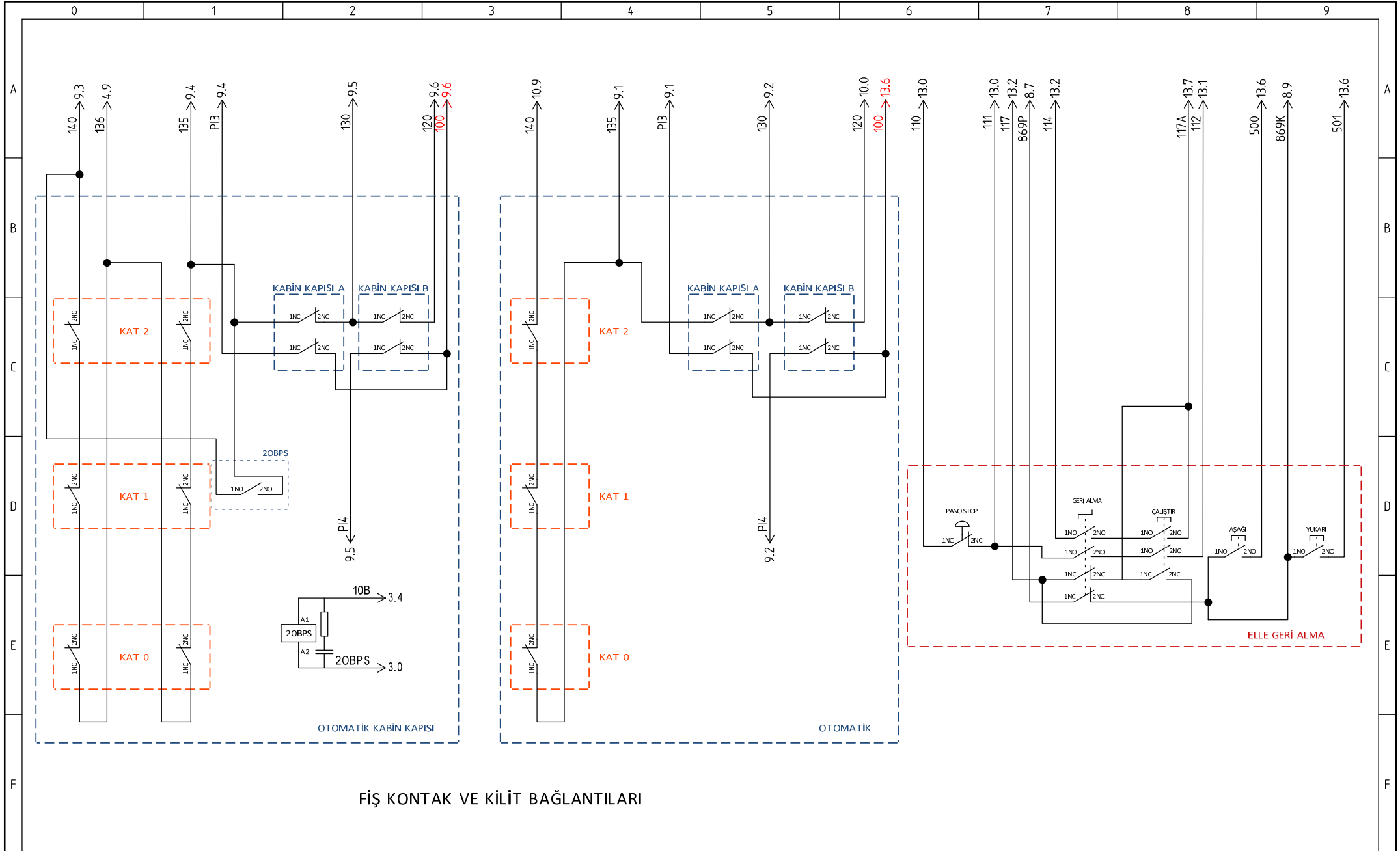

FİŞ KONTAK VE KİLİT BAĞLANTILARI

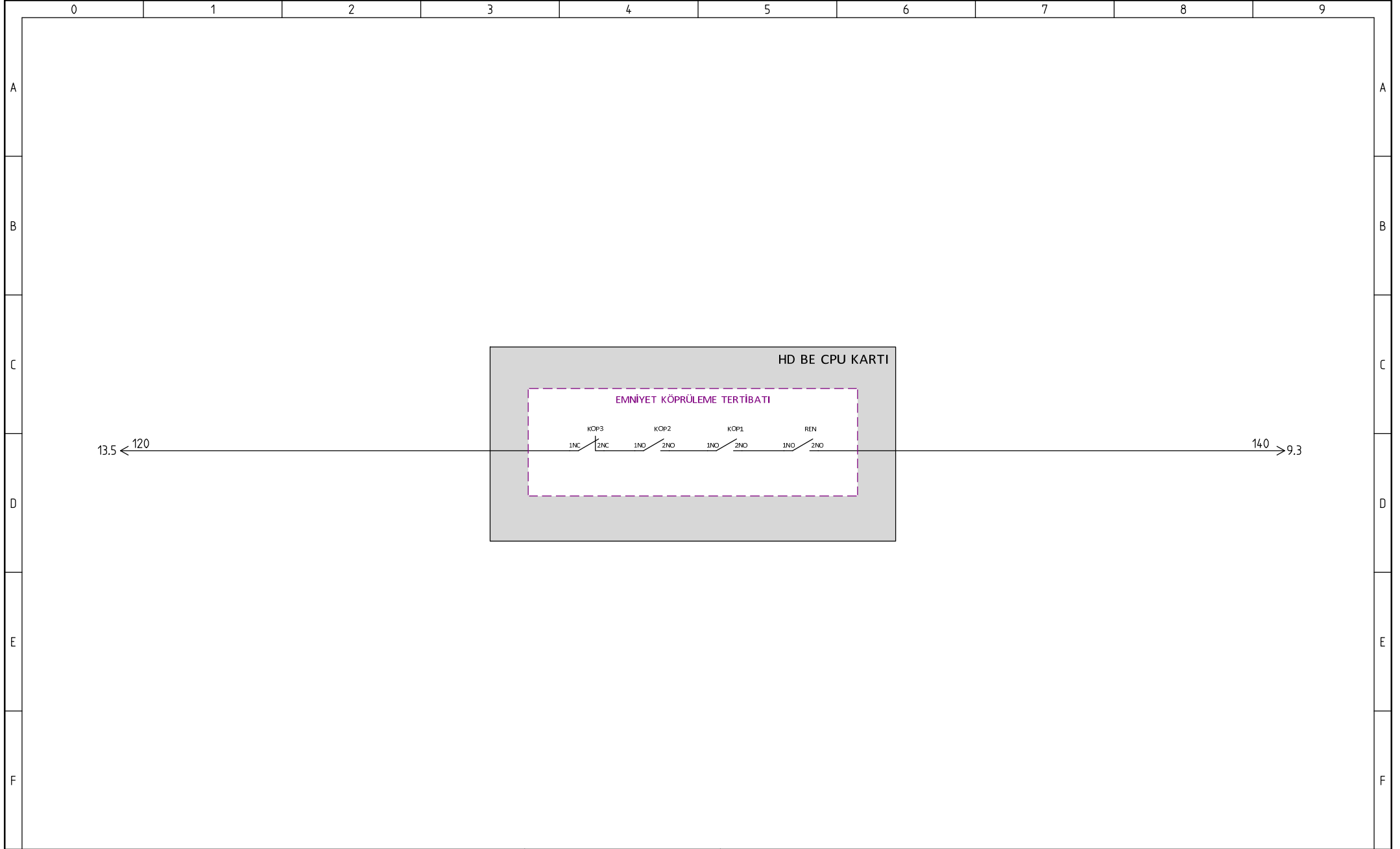

0 1 2 3 4 5 6 7 8 9

A

B

C

D

E

F

A

B

C

D

E

F

FREN TEST A

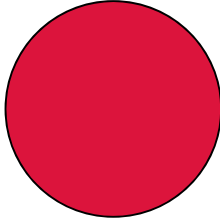

FREN TEST B

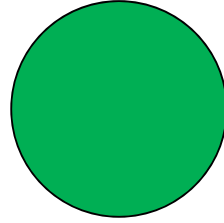

REGÜLATOR
KİLİT

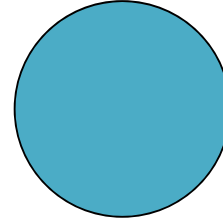

REGULATOR
BIRAK

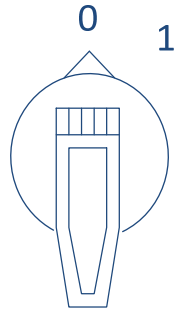
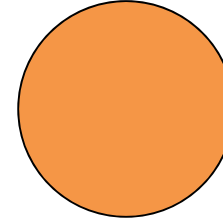

FREN TEST

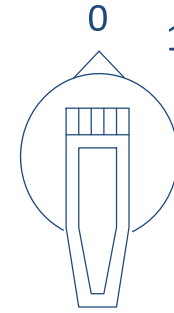

REGÜLATOR TEST

Not: Fren test kutusunu örnekteki gibi etiketleyiniz.

